

SEZ. A-A

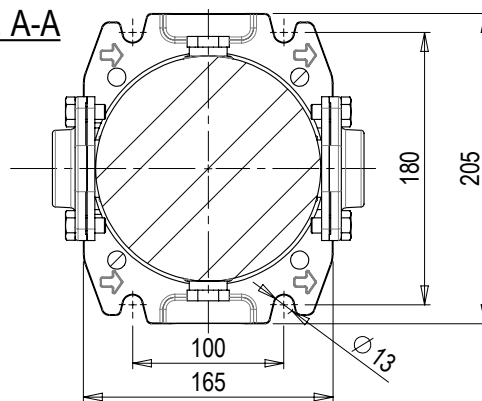

Note: Notes:			Tolleranze non indicate: Tolerances not indicated:		
Smussi non quotati: Unlisted chamfers:	Raggi non quotati: Unlisted rays:	Sforni non quotati: Unlisted draft angles:	Finitura: Surface quality:		
Descrizione / Description:			Quota di controllo: Control dimension:		
<h2>POMPA MXV 32-508 O CON MOTORE</h2>			Materiale: Material:		
			Trattamenti: Treatments:		
			Peso grezzo kg: Raw weight kg:	Peso finito kg: Finish weight kg:	
	Formato: Size: <b>A4</b>	Modello-Stampo: Model-Mold:	N° Disegno / Drw N°:	Vers:	Foglio / Sheet:
	Dimensioni in mm Dimensions in mm	Dipartimento: Department: <b>Z14</b>	10008483	01	1/1
Scala / Scale: 1:5	Data / Date: 14.06.2021	Disegnato / Drawn: DS00273	Approvato / Checked:		